

HOOGWERKER VERHUUR

Compacte verrijdbare lichtgewicht hoogwerker

Genie runabout GR-12

werkhoogte	5,28 m
Platformhoogte	3.45 m
Platform L x B	0,89 x 0,75 m
Platform (uitschuifbaar) L x B	1,40 x 0,75 m
Apparatuur afmetingen. L / B / H	1,35 x 0,75 x 1,57 m
Capaciteit	227 kg
maximale belasting platform	113 kg
Personen	1
Gewicht	717 kg
grondspeling	6 cm
maximum snelheid	4 km /h

€ 55,- per dag

€ 110,- per week

€ 380,- per maand

inclusief verzekeringspremie.



*Verrijdbaar op volle hoogte.

*Compact en laag gewicht; past in de meeste personenliften.

*Kan door deuropeningen gereden worden met bestuurder aan boord.

*Boorddiagnose voor gemakkelijk onderhoud.

*Extra platform verlagings – stelt afdaling in, in het geval van stroomstoring.

*Scharnierende klep voor makkelijke toegang tot de belangrijkste onderhoudscomponenten.

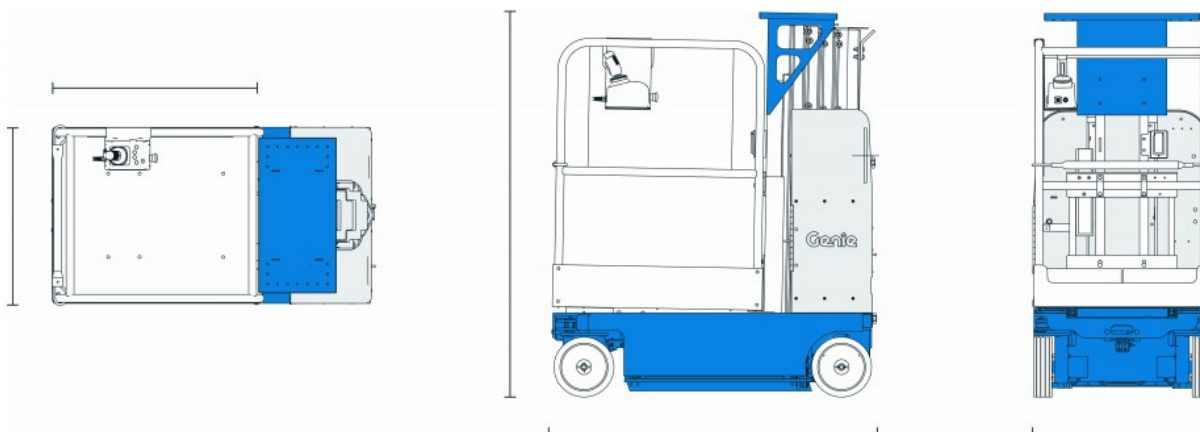

SCHAARHOOGWERKER

JLG 2030 ES

werkhoogte	8,1 m
Platform L x B	0,76x2,3 m
Beugel ondersteuning L x B	-
Apparaat afmetingen. L / B / H	2,3x0,76x1,82 m
netto gewicht	2065 kg
Personen	2
netto belasting	360 kg
platformverlenging	0,9 m
proportionele regeling	-

€ 55,- per dag

€ 120,- per week

€ 410,- per maand

inclusief verzekeringspremie.

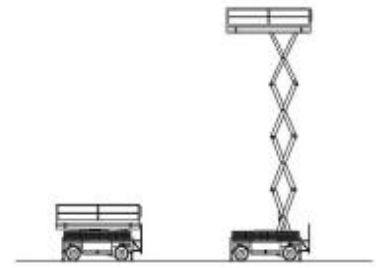

TELESCOOP

Manitou 150 AET

werkhoogte	14,85 m
Platform L x B	1,5x0,8 m
Beugel ondersteuning L x B	-
Apparaat afmetingen. L / B / H	-
netto gewicht	7085 kg
Bereik horizontaal	8,9 m
Personen	2
netto belasting	230 kg
proportionele regeling	-
Max klimvermogen	-

€ 155,- per dag

€ 360,- per week

€ 1.270,- per maand

inclusief verzekeringspremie.

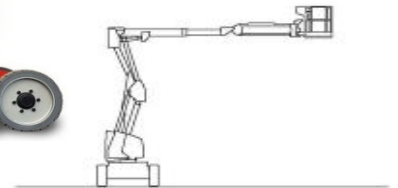
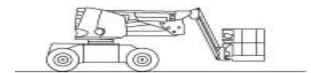

SCHAARHOOGWERKER

UpRight X 32

werkhoogte	11,8 m
Platform L x B	2,21x1,17 m
Beugel ondersteuning L x B	-
Apparaat afmetingen. L / B / H	-
netto gewicht	2531 kg
Personen	-
netto belasting	318 kg
platformverlenging	0,9 m

€ 110,- per dag

€ 260,- per week

€ 910,- per maand

inclusief verzekeringspremie.

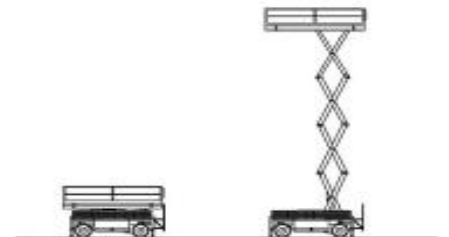

Knik Telescoop hoogwerker DIESEL 16m

Manitou 160 ATJ

werkhoogte	16,25 m
Platform L x B	1,8x0,8 m
Beugel ondersteuning L x B	-
Apparaat afmetingen. L / B / H	5x2,3x2,37 m
netto gewicht	7450 kg
Bereik horizontaal	9,1 m
Personen	2
netto belasting	230 kg
proportionele regeling	-
Max klimvermogen	-

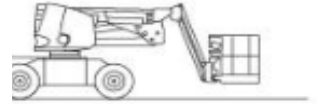
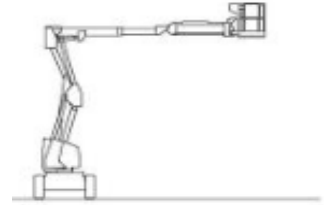

€ 180,- per dag
€ 437,- per week
€ 1.385,- per maand
inclusief verzekeringspremie.

Knik Telescoop hoogwerker DIESEL 21m

JLG 600 AJ

werkhoogte	20,46 m
Platform L x B	0,91 x 1,83m
Beugel ondersteuning L x B	-
Apparaat afmetingen. L / B / H	8,82 x 2,45 x 2,56 m
netto gewicht	10830 kg
Bereik horizontaal	11,81 m
Personen	2
netto belasting	230 kg
proportionele regeling	-
Max klimvermogen	45%

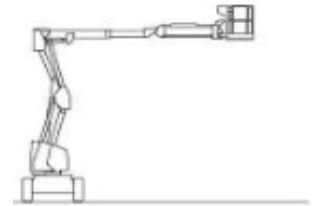

€ 242,- per dag
€ 622,- per week
€ 1.970,- per maand
inclusief verzekeringspremie.

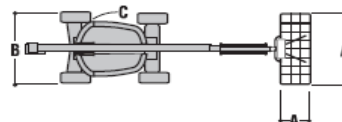
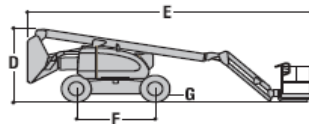
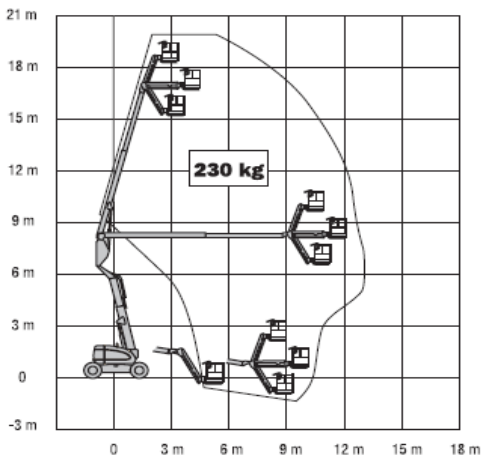

Verreiker Manitou MT 932 SLT (4 x 4 x 4) (9M)

MT932SLT

Laadvermogen	3200 kg
Hefhoogte	9.00 m
Laadgewicht op max. hefhoogte	1500 KG
Bereik horizontaal	6.58 m
Maximaal laadgewicht horizontaal	500 kg
Apparatuur afmetingen. L / B / H netto gewicht	4,68 x 2,34 x 2,30 7980 KG
doorrijhoogte	2.30 m
maximum snelheid	25 km/h

€ 210,- per dag

€ 610,- per week

inclusief verzekeringspremie.



MT 932

Machine sur pneus avec fourches

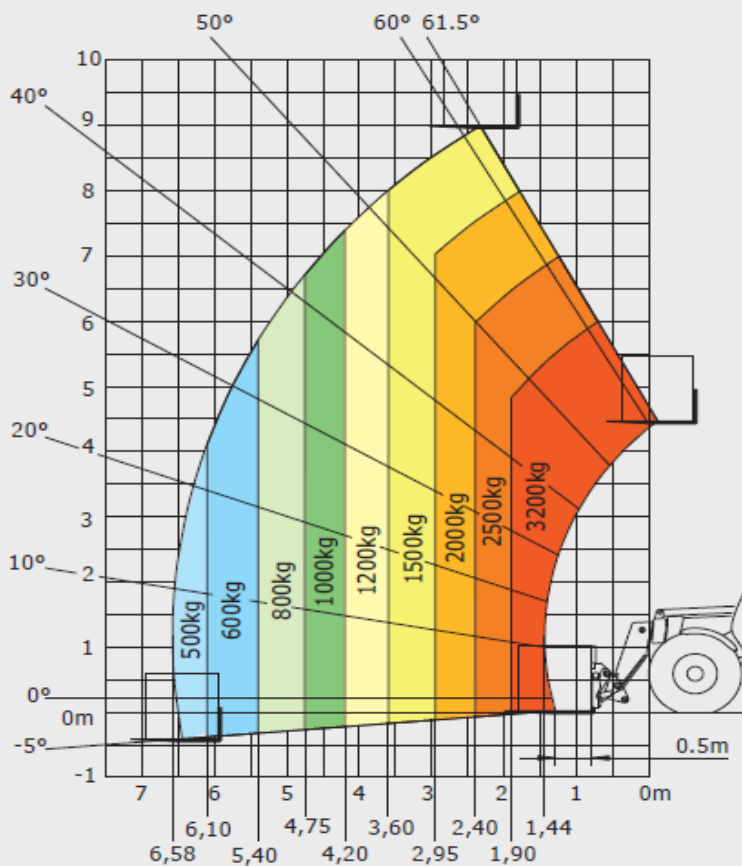

Verreiker Manitou MT 1440 (4 x 4 x 4) (14M)

MT 1440

Laadvermogen	4000 kg
Hefhoogte	13,53 m
Laadgewicht op max. hefhoogte	2000 KG, op stabilizer 3000 kg
Bereik horizontaal	9.50 m, op stabilizer ook 9,50 m
Maximaal laadgewicht horizontaal	300 kg, op stabilizer 1500 kg
Apparatuur afmetingen. L / B / H netto gewicht	6,13 x 2,37 x 2,45 m 11600 kg
doorrijhoogte	2.45 m
maximum snelheid	25 km/h



€ 240,- per dag

€ 760,- per week

inclusief verzekeringspremie.

MT1440

Rough terrain load chart
standard EN1459 B

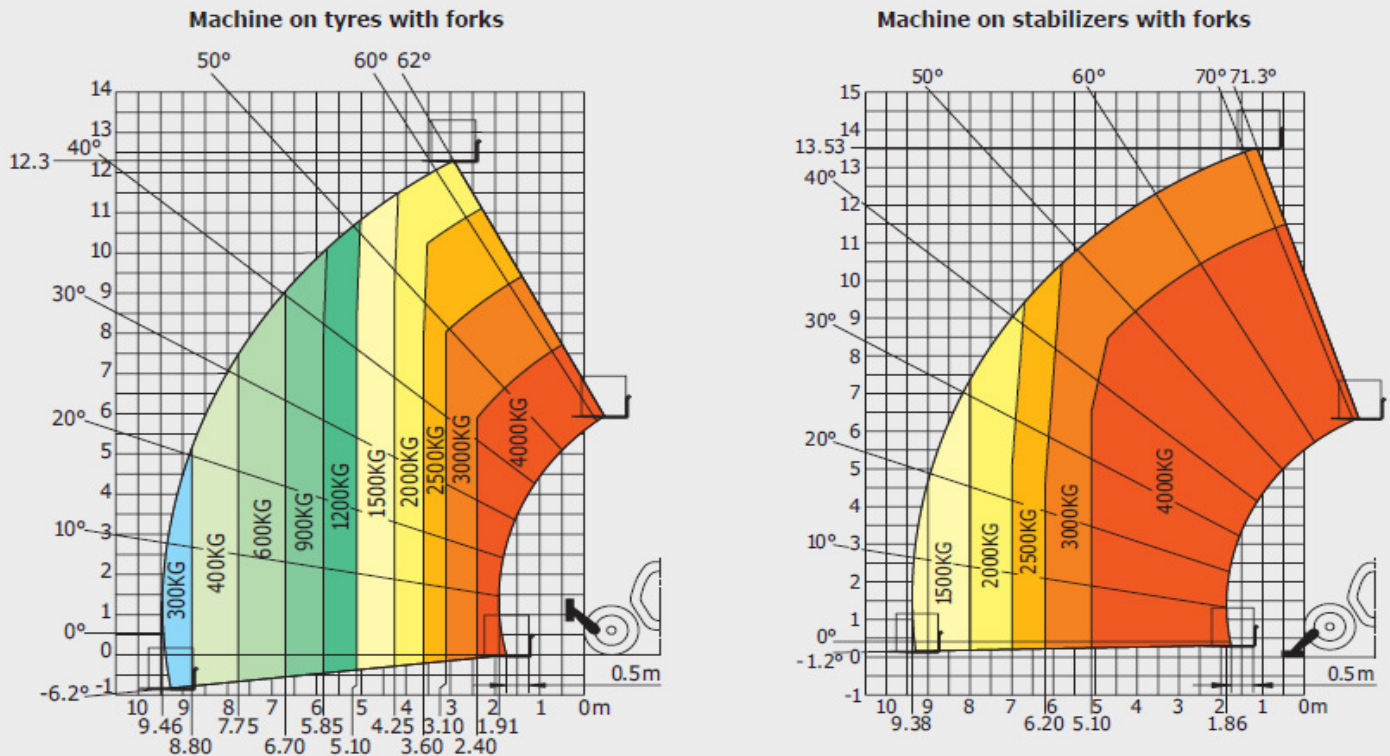

Verreiker Manitou MT 1840 (4 x 4 x 4) (17,50M)

MT 1840

Laadvermogen	4000 kg
Hefhoogte	17,5 m
Laadgewicht op max. hefhoogte	2000 kg, op stabilizer 2500 kg
Bereik horizontaal	9.50 m, op stabilizer 13 m
Maximaal laadgewicht horizontaal	400 kg, op stabilizer 850 kg
Apparatuur afmetingen. L / B / H netto gewicht	6,27 x 2,42 x 2,50 m
12400 kg	
doorrijhoogte	2.50 m
maximum snelheid	25 km/h



€ 325,- per dag

€ 850,- per week

inclusief verzekeringspremie.

MT1840



Rough terrain load chart
standard EN1459 B

Machine on tyres with forks

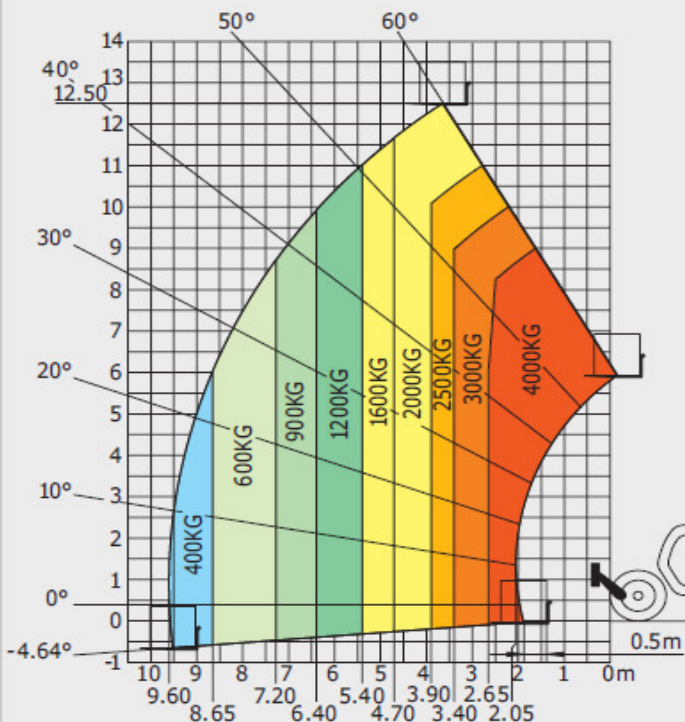

Machine on stabilizers with forks

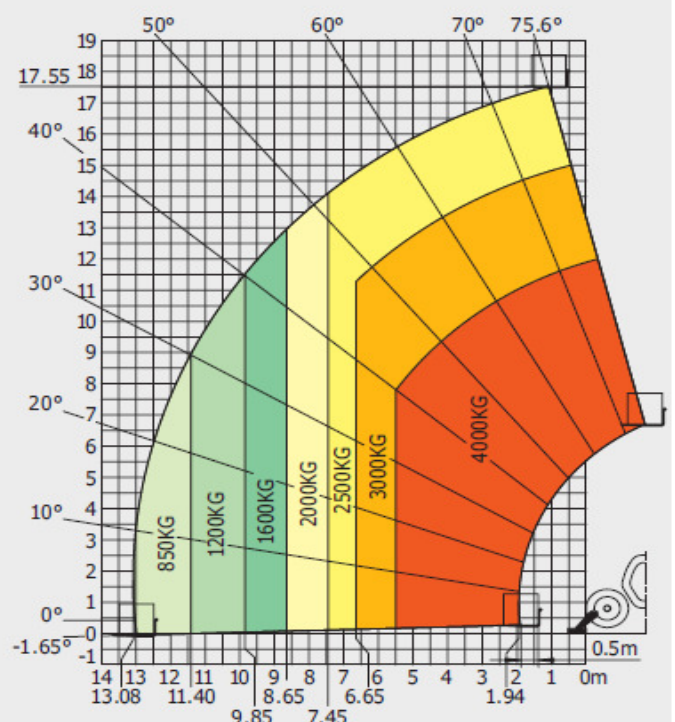

VLAARDINGEN - TEL: 010 435 72 73

Disclaimer: Deze specificaties kunnen niet exact overeenkomen met dit machine model, zij dienen alleen te worden gebruikt als richtlijn.